



02/2015 S220GB151S00

Our policy of constant technological upgrading means that technical specifications may be subject to change without prior notice.



## S220TR |

Versatility at its very best

**Sede Legale ed Amministrativa / Headquarters**  
CEFLA s.c.  
Via Selice Prov.le, 23/a  
40026 Imola (BO) - Italy  
Tel. +39 0542 653111  
Fax +39 0542 653344



**Produttore / Manufacturer**  
Cefla Dental Group  
Via Bicocca, 14/C - 40026 Imola (BO) - Italy  
Tel. +39 0542 653441 - Fax +39 0542 653601  
[www.sternweber.com](http://www.sternweber.com)  
[sternweber@sternweber.com](mailto:sternweber@sternweber.com)



# INNOVATION IS POWER



**HEALTH FACILITY  
MANAGER**

"Stern Weber just keeps on getting better. That's why it's the benchmark brand in the Dentistry Department".



**ENDODONTICS SPECIALIST**

"First-rate materials, user-friendly controls, all-round hygiene safeguards. Stern Weber gives me everything. Workplace safety at all times."



**IMPLANTOLOGIST**

"Cutting-edge instruments, perfect control and precise settings plus a patient chair that really makes the difference. For my specialisation, Stern Weber is the very best."

Evolution aims at perfection, finest details and rigorous constant improvement. Stern Weber's DNA is based on the wonders of technology, on enthusiasm for innovation, on the strength of genuine novelty. Rigour and precision are the key aspects of each new product, and the shapes of new design infuse such products with life. We believe in flexible working, in the perfection of true talent, in the importance of concrete steps being made towards true progress. We foresee the future today to guarantee a more innovative tomorrow.



# FLEXIBILITY ZONE

With the S220TR we've introduced a series of extremely versatile models. Whatever your operating style, we provide a practical ergonomic solution that suits it perfectly. For those seeking cutting-edge performance, we offer technologically advanced devices and instruments. For those who demand uncompromising safety, we offer a broad range of validated hygiene systems. And for those looking to optimise workflows, we offer smoothly integrated multimedia and X-ray diagnosis systems. S220TR: for those who want an integrated treatment centre that can be moulded around their needs.

















**Pneumatic lock**  
The dentist's module arm features an optional pneumatic brake. Activated via the button on the handle, this device allows precise height adjustment at the click of a switch.



**Chair with cuspidor**  
A version without a dentist's module is also available, allowing configuration of the 5-holder assistant's module with a dynamic instrument or with the camera.



**Assistant's module**  
Assistant's module assembled on jointed arm, which also features extensive vertical adjustment.

#### Ergonomics to enhance your individuality

Classic and innovative ergonomics. Six models that cover a vast range of dentistry needs. For dentists who operate in indirect vision mode, the **International** model provides a solution that is as comfortable as it is flexible.

**Side Delivery**, with an adjustable dentist's module installed on a cast aluminium metal support structure, ensures outstanding stability while the **Cart** provides full freedom of movement. The **Continental** provides optimal instrument manoeuvrability and a pantograph arm that passes over the patient for hindrance-free positioning, while the **Hybrid** model offers absolute versatility as it can be used by both right and left-handed dentists.





**Repositionable control panel**  
Available exclusively as a Continental model, the S220TR HYBRID features a repositionable instrument control panel that completes module transformation when configured for left-handed dentists.



**Quick coupling**  
All that needs to be done is to detach the instrument control panel, rotate the quick coupling 180° and then reposition the former on the opposite side of the module.

**A hybrid model offering unparalleled versatility**

The S220TR HYBRID provides peak ergonomic versatility. The dentist's module rotates 340° to reach positions all around the patient while the assistant's module can be shifted right or left and remains independent from dentist's module rotation. Exceptional operating freedom whether working alone or with an assistant.

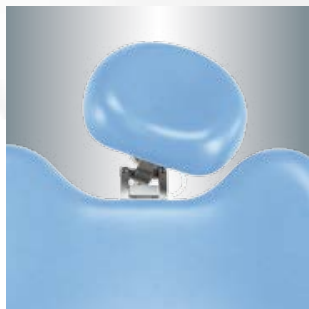

**Atlaxis**  
Another available option on the S220TR is the Atlaxis pneumatic headrest, which can be positioned without mechanical levers or brakes. Using just one hand, the dentist can release the headrest and reposition it comfortably, gently accompanying the movements of the neck joint. In addition, the headrest vertical movements can be adjusted via the support rod.



**Memory Foam**  
Optional Memory Foam padding ensures greater patient comfort and relaxation. Available in 8 colours.



**Side Delivery**  
On the Side Delivery model the dentist's module remains behind the backrest when patients access to the chair, therefore remaining outside their field of vision.

**Built-in comfort**

Each specific component is designed with the same conscientiousness that Stern Weber dedicates to continuous research, providing solutions that evolve together with the needs of the dentist. In addition to ergonomics, the comfort factor is of prime importance, because a patient at ease enhances the working effectiveness of the medical staff. Special patient chair shaping makes it easier for staff to get in close to the operating zone: also features Trendelenburg movement and a 190 kg lift capacity.





- Venus Plus - L LED**
- Light intensity from 3,000 to 50,000 Lux
  - Adjustment via potentiometer or no-touch sensor
  - Colour temperature: 5,000 K
  - 3-axis rotation
  - Low-thermal emission LED light sources
  - LEDs guaranteed to work 50,000 hours



- Venus Plus**
- Light intensity from 8,000 to 35,000 Lux
  - Potentiometer and soft-start device
  - Colour temperature: 4,900 K
  - 3-axis rotation



**Power Pedal Foot Control**



**Pressure-operated Foot Control**



**Multi-function Foot Control**

Foot controls can be used to operate patient chair movement, activate Chip Air and Chip Water on the instrument in use and also activate the extracted instrument (with and without spray).



**Personalisation as a key value**

A key aspect of the Stern Weber philosophy is that of leaving dental unit personalisation to the dentist, allowing him to express his professionalism in full. Not just in terms of ergonomic configurations and colour schemes, but also as regards hygiene systems, instruments, foot controls and operating lights. Because the Stern Weber world is your world.





**Assistant's module**

The assistant's module incorporates controls for movement of the patient chair, switching on the operating light and the water to cup and cuspidor bowl rinse functions.



**Additional module**

As an option, the assistant's module can also incorporate an add-on unit for camera and T-LED light.

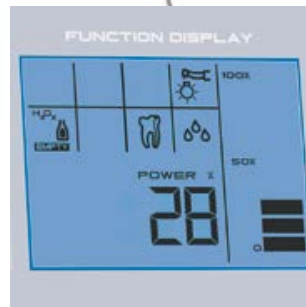

**Power adjustment**

The instrument control panel can be used not only to read data, but also adjust micromotor speed (effective rpm) and power (expressed as a percentage) where a turbine and scaler are installed.

**When control becomes simple**

Easily read, the data shown on the large LCD display concerns instrument parameters and dental unit operating status. Icons for control of patient chair, main instrument settings, systems and accessories are arranged on the keypad logically and intuitively.

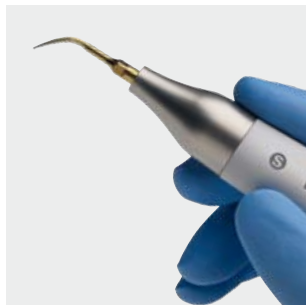

#### SC Scalers

Indicated for supragingival prophylaxis tasks of the periodontal type and for the preparation of small cavities and in endodontic root canal cleaning techniques. Power levels are shown on the display.



#### i-XR3 / i-XR3L

The induction technology on this micromotor cuts maintenance needs to a minimum. Suitable for conservative and prosthetic dentistry, the micromotor can be cold-disinfected. On the 3L version LED lighting is also incorporated.

- Torque up to 3,3 Ncm
- Speed range from 100 to 40,000 rpm
- Dimensions: Ø22 x 34 mm
- Weight: 67 g

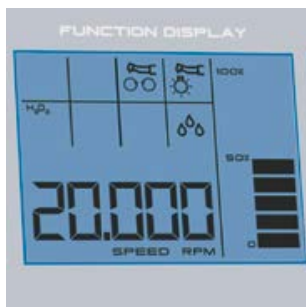

#### Data display

Micromotor parameters - speed, spray feed, light - are presented via numerical data and user-friendly icons.



#### Quick couplings

Tubing on both dentist's and assistant's modules can easily be replaced via the quick couplings.

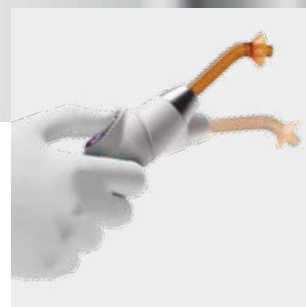

#### T-LED

Features 6 programmes for polymerisation and bonding tasks. Depending on the programme, delivered energy ranges from 11,250 mJ to 36,000 mJ. A special key on the control panel reduces operating light intensity to a level that prevents interference with composite polymerisation.



#### Performance to match your talent

The extensive range of exclusive instruments means that Stern Weber offers nothing less than the very best performance. Dentists can configure the dental unit in the knowledge that sophisticated, reliable electronics provides complete integration of instruments, allowing them to place complete trust in the tools at their disposal and so express their skills in full. On each version (except for S220TR Hybrid), it's also possible to complete the dentist's module with an optional sixth instrument: camera or curing light.





**Zen-X**  
X-ray sensor integrated on the dentist's module. Well-built, ergonomic and available in two sizes, contains a CMOS sensor for high resolution images.

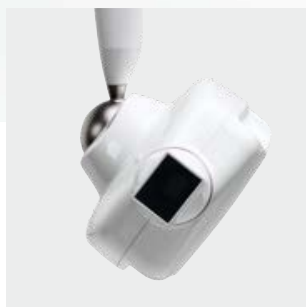

**RXDC HyperSphere+**  
DC X-ray unit with integrated 30 cm collimation, designed for digital radiology. Provides pin-sharp images thanks to a focal spot of just 0.4 mm.



**Spherical ball-joint**  
A spherical ball-joint and a lock/release mechanism activated by 2 touch-sensitive areas on the tube head ensure that positioning is both fast and precise.



**Wireless handheld unit**  
The handheld wireless control device features 4 keys to adjust exposure and another key to take the X-ray. The RXDC automatically calculates the correct exposure on the basis of the selected anatomic area.

**Perfectly integrated with your individuality**

Stern Weber offers you a solution of outstanding practicality and versatility: the X-ray system integrated on the dental unit. Not just any system but a set of cutting-edge devices, each created around new technologies that boost your diagnostic capabilities. Consisting of an X-ray unit with wireless control, digital sensor and medical-grade LED monitor, the integrated X-ray diagnosis system eliminates all the inconveniences associated with separate equipment installation.

**19" LED Monitor**  
 CE 93/42 certified, the 16:9 monitor comes complete with a lead for connection to the PC. LED light sources ensure outstanding contrast and brightness. A touch-screen version is also available.



**Double-articulated arm**  
 For the touch-screen version the optional double-articulated arm is recommended to move the screen in closer or further away from the operating zone. The screen is also tilt-adjustable.

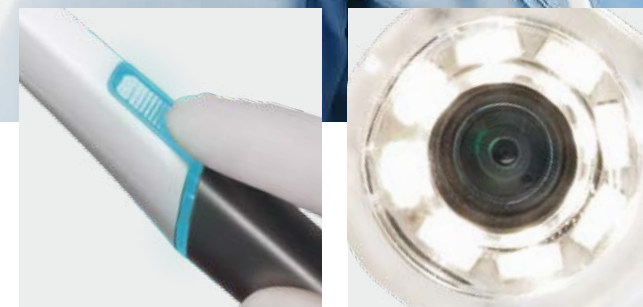

**C-U2 HD camera**  
 A digital camera with HD sensor and glass optics, the C-U2 provides high-resolution images in full-screen format on the LED monitor. The optical system with 7 glass lenses and a F/8 aperture guarantees excellent brightness and an extensive depth of field (min. 5 mm max. 70 mm) with any need for manual focussing. The backlit multi-function button enables the operator to freeze frame images and to subsequently store them.

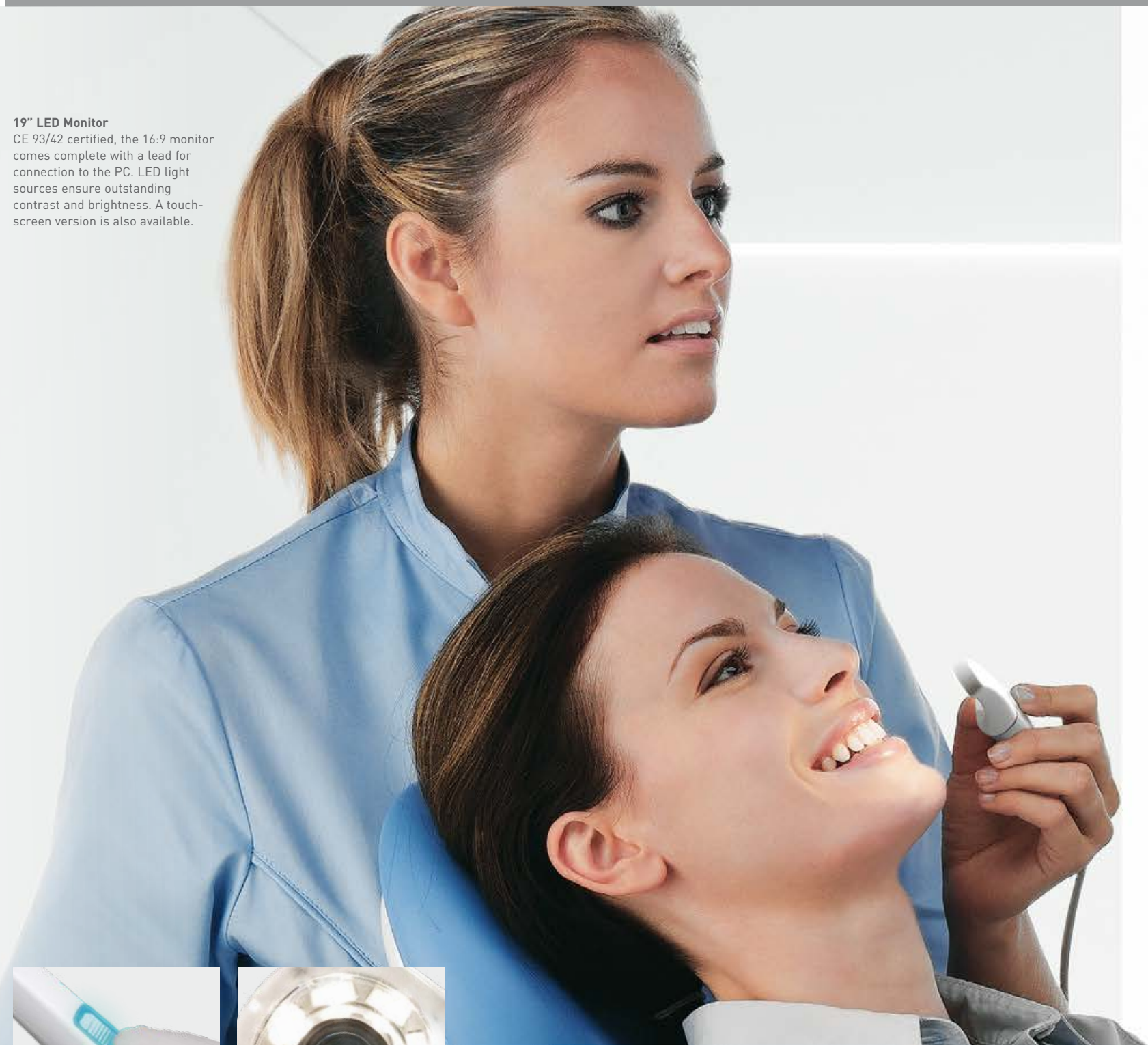

**The pleasure of communication**

Being able to provide a clear explanation of treatment and illustrate the achieved results provides a simple way of reassuring patients and strengthening their trust in the dentist. Such tools are equally reassuring for the dentist, who can count on the extremely practical technology of Stern Weber multimedia devices.

Perfectly integrated with the dental unit electronics, the new 16:9 format high definition camera with HD sensor and 19" flat screen monitor are extremely simple to use and provide instantaneous communication with patients.



**W.H.E. (Water Hygienisation Equipment)**

Used with the EN 1717-compliant air gap system that separates the mains water supply from the dental unit, the **W.H.E.** system adds **Peroxy Ag+ [H<sub>2</sub>O<sub>2</sub>]** to the mains water fed to the dental unit. At the recommended concentration of 600 ppm, this is highly effective against all water-borne contaminants, including Legionella.



**Removable parts**

In addition to the active system, dental unit design also features numerous removable elements such as cuspidor bowl and upholstery, plus surfaces that are easily sanitised.



**Instrument support**

The instrument holder panel is removable and the soft, silicon instrument mat is both removable and autoclavable.



**Padding**

Surfaces coated with polyurethane paint or made of techno-polymers highly resistant to chemical disinfectants. Upholstery is removable and easily sanitised.



**Easy access**

The unit body covers the entire side of the unit. Makes access for maintenance tasks easier.



**Double filters**

Extensive filtration surface area on the double filters ensures maximum efficiency and reduces emptying frequency. Independent filter selection is available as an optional function.



**Cannula roller guides**

Holder guides provide support during extraction and replacement of the suction cannulae. The roller housing can easily be removed for disinfection and cleaning purposes.



**Cannulae terminals**

The cannulae terminals, like other elements on the dental unit, are removable and autoclavable.



**Disposable covers**

Dentist's and assistant's module feature disposable covers.



**Automatic Chip Air**

This system, featured as standard, automatically emits an air jet when you stop using dynamic instruments so as to clean any residual liquids or solids from the handpiece.



**SANASPRAY S**

Distilled water can be used by bypassing the mains water. To carry out rapid circuit sanitisation a second tank is available. Given its tried and tested effectiveness, the use of **Peroxy Ag+** disinfectant is recommended.

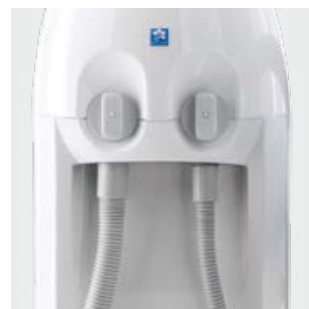

**A.C.V.S.**

Automatic system that carries out suction system sanitisation cycles between one patient and another.

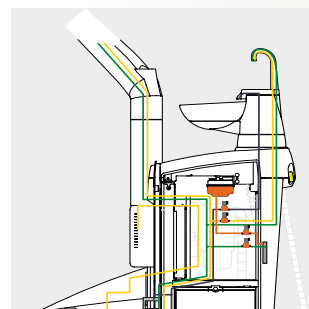

- BIOSTER S
- W.H.E.
- SANASPRAY S
- A.C.V.S.
- Mains water



**Safety systems ready for anything**

When we design a Stern Weber product, we certainly don't let our guard down when it comes to hygiene. For us, protecting dentists, assistants and patients from the risks of cross-contamination is more than a practical, conscious decision - it's a duty. Which is why Stern Weber offers hygiene devices of scientifically proven effectiveness. All you have to do is choose the desired level of protection.

Semi-automatic system controlled via the dentist's instrument control panel. Using the special liquid disinfectant tank, applied in place of the independent feed tank, **BIOSTER S** disinfects the spray circuits.

The **I.W.F.C.** device ensures effective cleaning of dental unit water circuits after a period of machine idleness.

S220TR	SIDE DELIVERY	INTERNATIONAL	CART	CONTINENTAL	CHAIR WITH CUSPIDOR	HYBRID
<b>HYGIENE SYSTEMS</b>						
BIOSTER S	*	*	*	*	-	*
A.C.V.S.	*	*	*	*	*	*
SANASPRAY S	*	*	*	*	*	*
W.H.E.	*	*	*	*	*	*
I.W.F.C.	*	*	*	*	-	*
<b>DENTIST'S MODULE</b>						
Micromotor i-XR3L with f.o. (100 – 40,000 rpm)	●	●	●	●	-	●
6-way syringe	●	●	●	●	-	●
Sixth instrument	*	*	*	*	-	-
X-ray viewer for panoramic X-rays	*	*	*	-	-	-
Integrated sensor	*	*	-	*	-	*
<b>UNIT BODY</b>						
Glass cuspidor bowl	●	●	●	●	●	●
Ceramic cuspidor bowl	*	*	*	*	*	*
Cuspidor bowl drive	*	*	*	*	*	*
Cup water heater	●	●	●	●	●	●
Spray heating	*	*	*	*	-	*
Independent cannulae selection	*	*	*	*	*	*
Assistant's module dynamic instrument (turbine, scaler or i-XR3)	-	-	-	-	*	-
Suction stop device on chair base	●	●	●	●	●	●
Multimedia applications wiring	*	*	*	*	*	*
Professional tray-holder	*	-	*	-	*	-
Assistant's tray-holder	*	*	*	*	*	-
Venus Plus-L LED operating light	*	*	*	*	*	*
<b>PATIENT CHAIR</b>						
Atlaxis headrest	*	*	*	*	*	*
Mobile, removable right armrest	*	*	*	*	*	*
Left armrest	●	●	●	●	●	*
Child's cushion	*	*	*	*	*	*
Multi-function foot control	●	●	●	●	*	●
Pressure-operated foot control	*	*	*	*	*	*
Power Pedal foot control	*	*	*	*	*	*
Multi-function (wireless) foot control	*	*	*	*	-	*
Pressure-operated foot control (wireless)	*	*	*	*	-	*
Full seat cover for patient chair	*	*	*	*	*	*

● as standard \* optional - not available

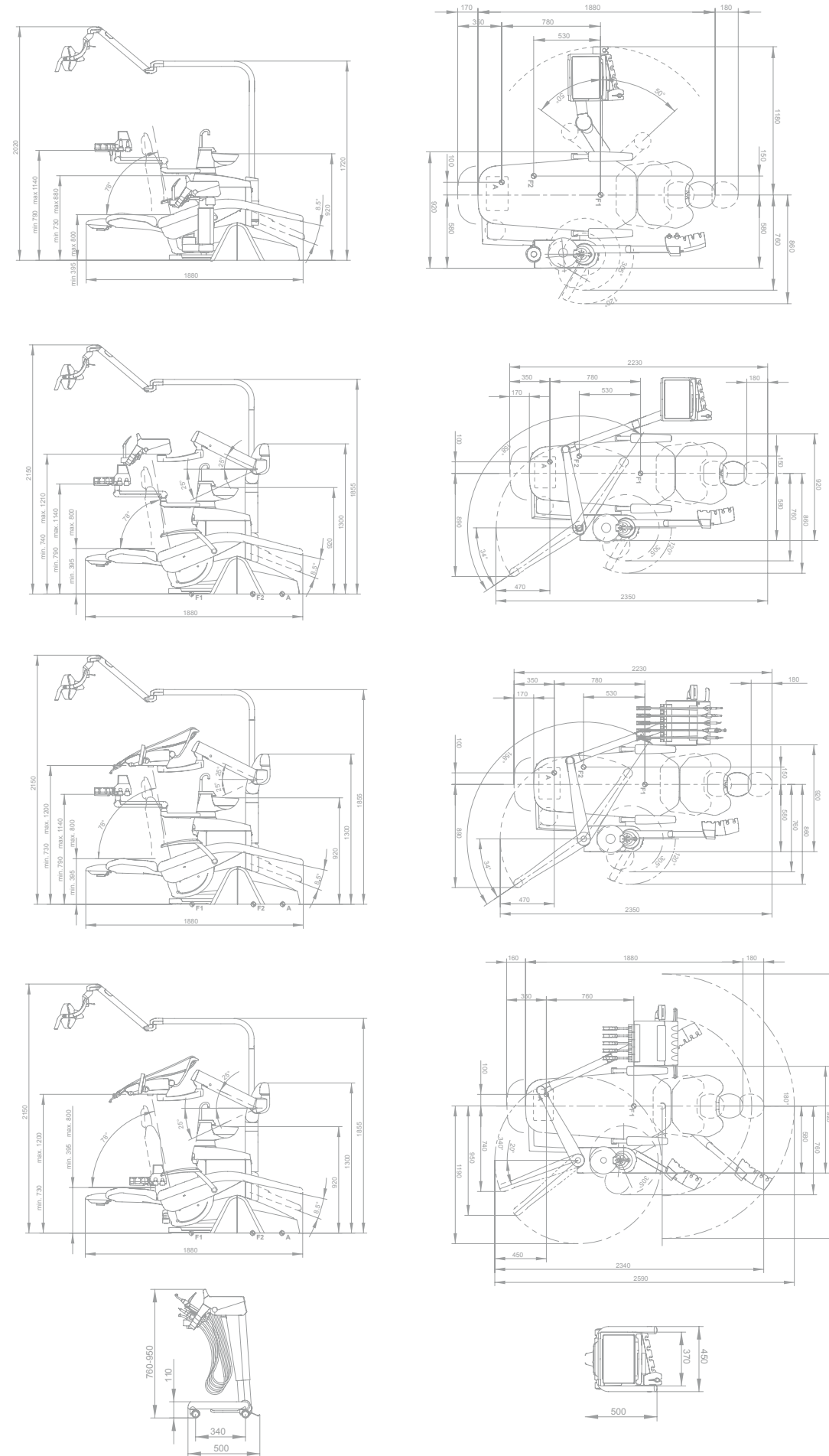

SIDE DELIVERY

INTERNATIONAL

CONTINENTAL

HYBRID

CART

Dimensions are quoted in millimetres.